



Electrolux
PROFESSIONAL

PLUS - Static Preparation 1400 mm Hot Cupboard with Upstand

ITEM # _____

MODEL # _____

NAME # _____

SIS # _____

AIA # _____



134051 (GTC1410E)

Hot Cupboard, with 100mm upstand, 1 shelf and 2 sliding doors, 1400mm

Short Form Specification

Item No. _____

Enhanced stability and solid construction thanks to the welded frame and legs and ventilated hot air flow system guarantees temperature evenness. Model specific to keep dishes warm. Can reach a maximum temperature of 70° in 45 minutes. The 50mm high worktop in 304 AISI stainless steel, with Scotch Brite finishing 15/10 mm in thickness, has anti-drip edges and welded corners. 18mm thick undertop waterproof reinforcement, it's completely waterproof, double-sided laminated and 100% recyclable. Sound-deadened double walled sliding doors on roll bearings with end limit stop (7/10 in thickness in 304 AISI stainless steel). Upstand h=100mm with 10mm radius corner covered on the back with AISI 304 stainless steel spot welded profile. Equipped with 40mm high hot intermediate shelf (8/10 in thickness) in 304 AISI stainless steel with upturned edges and AISI 304 bar reinforcement. Base panel in AISI 304 stainless steel (8/10 in thickness) with upturned edges reinforced by stainless steel AISI 304 bars. Welded to the legs for further structure reinforcement. Height adjustable feet (-20/+30 mm) in 304 AISI stainless steel.

Main Features

- Enhanced stability and solid construction. Stability, loading and stress tests by external certified body.
- Product range suitable for international tenders requirements for intense usage installations.
- Suitable to keep dishes warm up to an adjustable max temperature of 70°C (ventilated heating).
- 2h approximately warming time. Depending on dishes shape and dimension, warming time can vary.

Construction

- Welded frame and legs.
- Worktop with 50 mm high profile, in s/s Scotch Brite finishing, 15/10 in thickness with anti-drip edges and welded corners.
- Undertop is 18mm in thickness, reinforced, completely waterproof, double-sided laminated and 100% recyclable.
- Upstand back completely covered with Stainless Steel welded profile.
- Door sliding system is fluent and reliable, tested with over 80.000 cycles by external certified body.
- Sliding doors are in stainless steel and double-walled with sound-deadening material inside. They are 7/10mm in thickness with roll bearings and end limit stop.
- Cupboard interior has easy access thanks to completely openable doors.
- Intermediate shelf has 40mm high profile, is 8/10 in thickness with upturned edges and bar reinforcement. It can be positioned at three different heights.
- Base panel has 40mm high profile, is 8/10 in thickness with upturned edges and bar reinforcement. It is welded to legs for further structure reinforcement.
- Height-adjustable stainless steel feet (-20/+30mm).
- Constructed entirely in 304 AISI stainless steel.

Optional Accessories

- Set of 4 wheels (2 with brake), PNC 855207 □ diameter=125mm

APPROVAL: _____



Experience the Excellence
www.electroluxprofessional.com

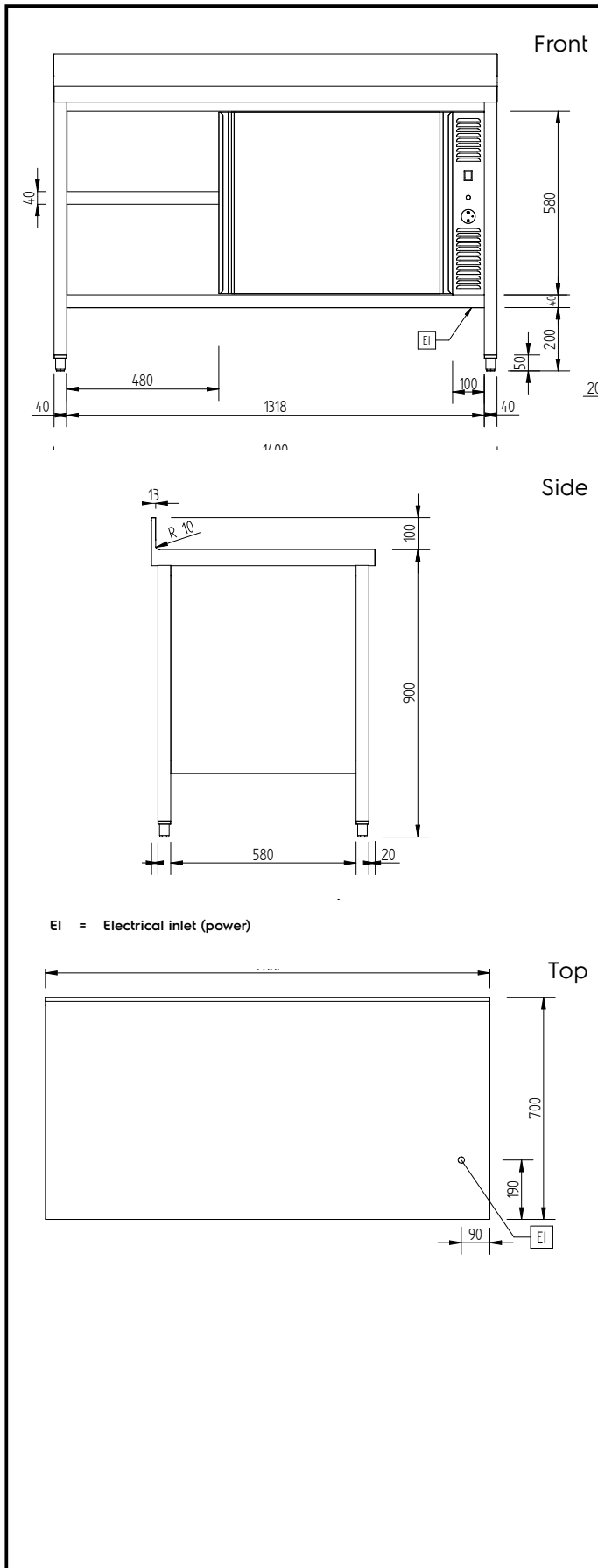

Electric

Supply voltage:

134051 (GTC1410E)

220-240 V/1N ph/50/60 Hz

Total Watts:

2.53 kW

Key Information:

Cabinet width:	1318 mm
Cabinet depth:	580 mm
Cabinet height:	580 mm
Cabinet temperature:	+30/+90 °C
External dimensions, Width:	1400 mm
External dimensions, Depth:	700 mm
External dimensions, Height:	1000 mm
Upstand Dimensions, Height:	100 mm
Upstand Dimensions, Depth:	13 mm
Upstand Dimensions, Radius:	R=10
Number and type of doors:	2 Sliding
Worktop thickness:	50 mm
Net weight:	81 kg
Adjustable Feet:	-20/+30 mm